

Nidec

Power



TAL 044

Low Voltage Alternator - 4 poles

Three-phase
70 to 200 kVA - 50 Hz / 88 to 250 kVA - 60 Hz

Dedicated single-phase
57 to 82 kVA - 50 Hz / 80 to 125 kVA - 60 Hz

Electrical and mechanical data

LEROY-SOMER™

TAL 044 - Three-phase & Single-phase

The best of performance

The Leroy-Somer™ TAL 044 alternator has been designed to offer you the best power generation performances. With its meticulous design and optimized architecture, the TAL 044 strikes the perfect balance between compactness, reliability, performance and longevity. Whatever your application, the Leroy-Somer™ TAL 044 alternator will meet your needs and will adapt to all situations.

Standards

The Leroy-Somer™ TAL 044 alternator meets all key international standards and regulations, including IEC 60034, NEMA MG 1.32-33, ISO 8528-3, CSA C22.2 n° 100-14 and UL 1446 (UL 1004 on request). Also compliant with IEC 61000-6-2, IEC 61000-6-3, IEC 61000-6-4, VDE 0875G, VDE 0875N and EN 55011, group 1 class A for European zone. The Leroy-Somer™ TAL 044 alternator can be integrated in EC marked generator set, and bears EC, UKCA and CMIM markings. It is designed, manufactured and marketed in an ISO 9001 and ISO 14001 quality assurance environment.

Electrical characteristics and performances

- Class H insulation
- Shunt excitation
- Low voltage winding:
 - Three-phase 50 Hz: 220V - 240V and 380V - 415V (440V)
60 Hz: 208V - 240V and 380V - 480V
 - Single-phase 50 Hz: 230V
60 Hz: 240V
- 4-terminal plates in 6-wire version
- Optimized performance

Excitation and regulation system

	Excitation system				Regulation options		
	AVR	SHUNT	AREP+ (option)	PMG (option)	ULc/us	Remote voltage potentiometer	C.T. Current transformer for paralleling
Three-phase 6-wire	R120	Standard					
	R150	Option				√	
	R180		Standard	Standard		√	√
	D350	Option	Option	Option	√	√	√*
Three-phase 12-wire	R120	Standard					
	R250	Option			√	√	
	R180		Standard	Standard		√	√
	D350	Option	Option	Option	√	√	√*
Single-phase	R121	Standard				√	
	R251	Option			√	√	

*: only with AREP+ or PMG

Protection system and options

- Degree of protection: IP 23
- Complete winding protection for non-harsh environment with relative humidity ≤ 95%
- Options:
 - Three-phase 12-wire with 8-terminal plates
 - AREP+ or PMG excitation
 - ULc/us
 - Customized painting (unpainted machine as standard)
 - Space heater
 - Flying leads
 - Droop kit for alternator paralleling
 - Dedicated single-phase
 - Stator sensors
 - Winding 8 optimized for three-phase 380V / 416V - 60Hz
 - Reinforced winding protection for harsh environments and relative humidity greater than 95% (system 2 - 4):
for TAL 044 K apply a derating coefficient of 0.97

Mechanical construction

- Compact and rugged assembly to withstand engine vibrations
- Steel frame
- Aluminum flanges and shields
- Single-bearing design compatible with most diesel engines
- Greased for life bearings
- Direction of rotation: clockwise and counterclockwise without derating

Terminal box design

- Easy access to AVR and terminals
- Possibility of current transformer for parallel operation

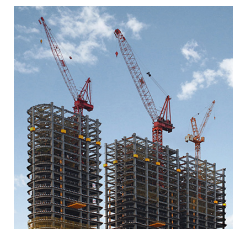

TAL 044 - Three-phase 70 to 200 kVA - 50 Hz / 88 to 250 kVA - 60 Hz

Efficiencies 400 V - 50 Hz (— P.F.: 0.8) (--- P.F.: 1)

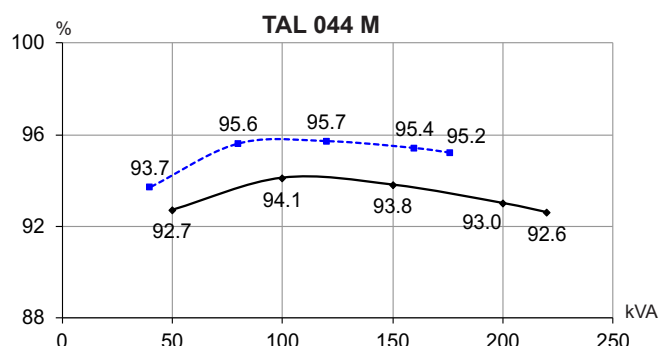
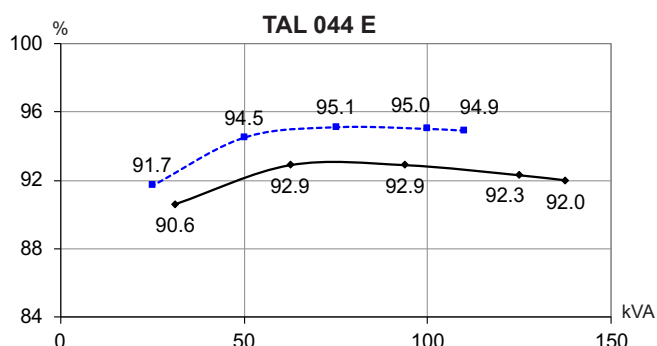
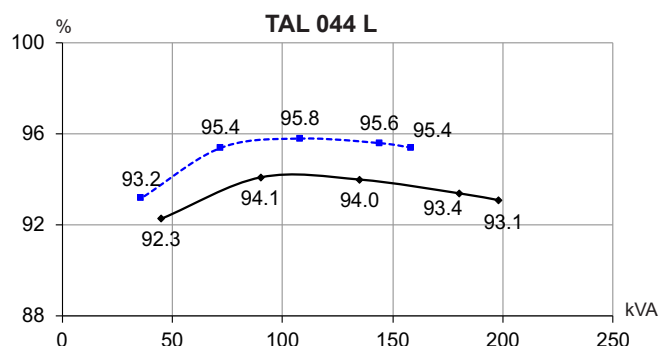
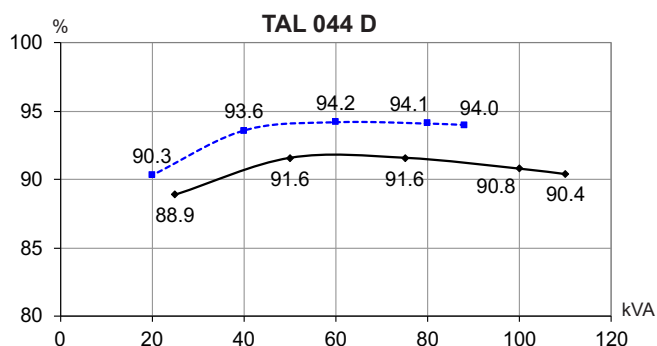
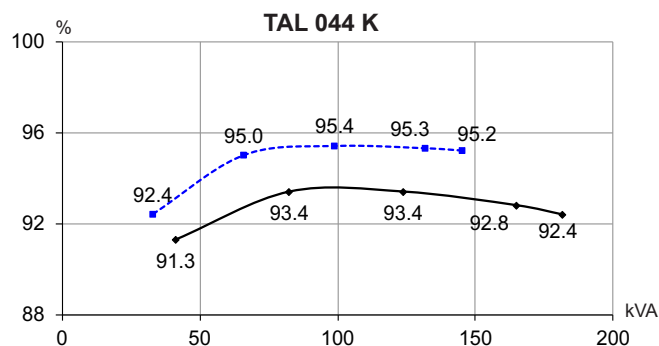
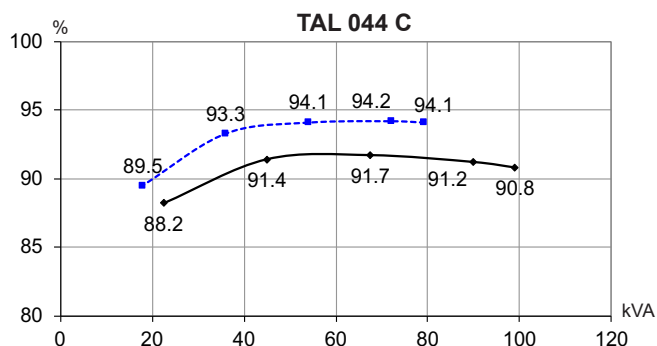
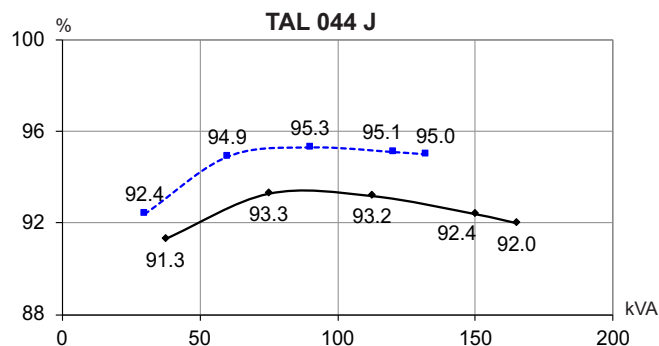
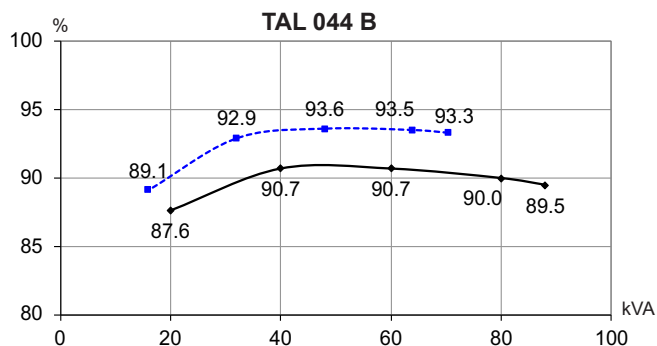
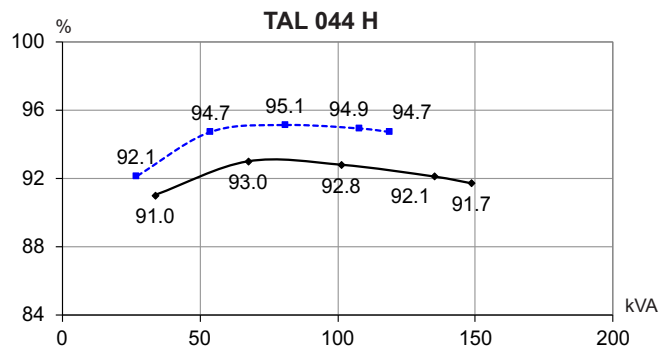
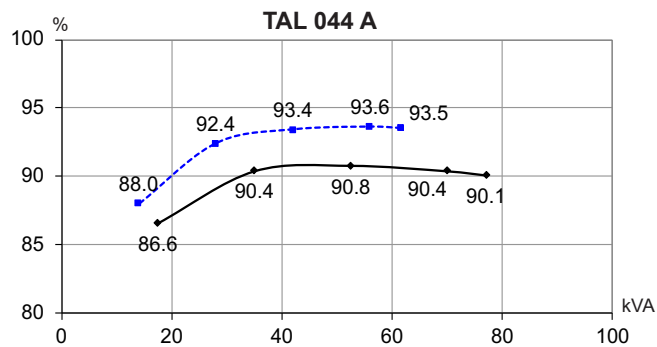

Efficiencies 480 V - 60 Hz (— P.F.: 0.8) (--- P.F.: 1)

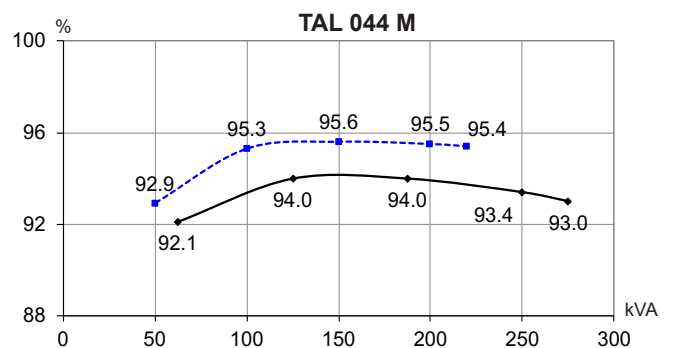
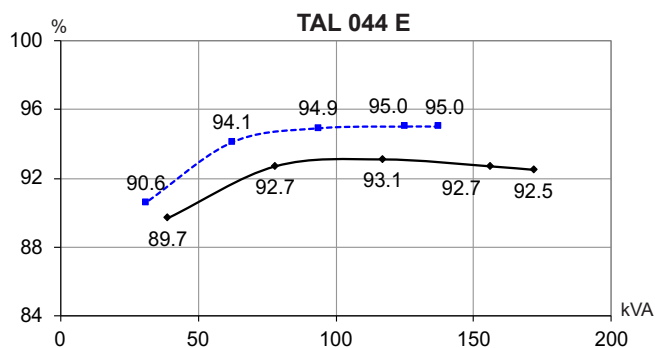
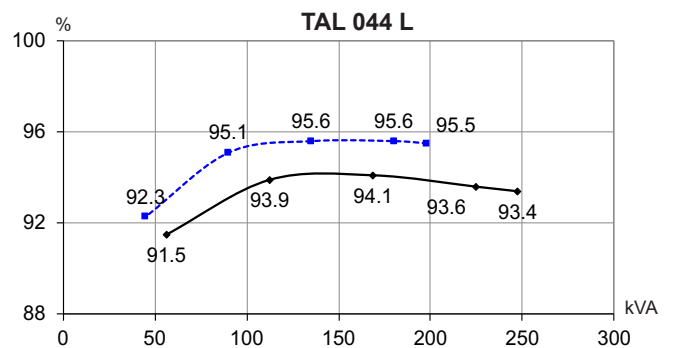
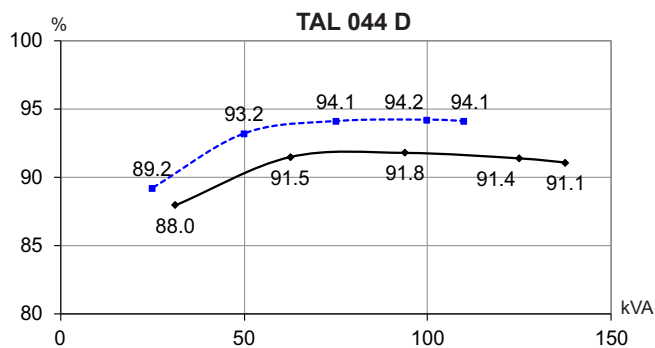
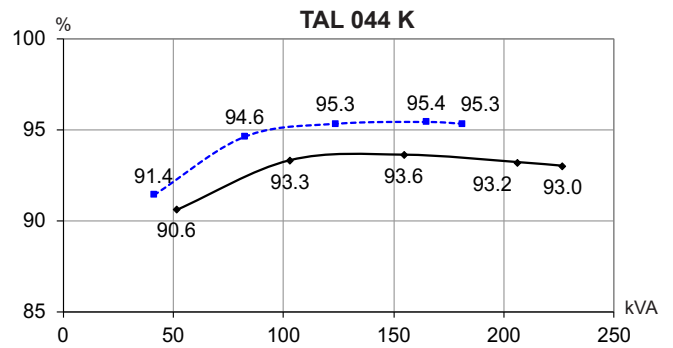
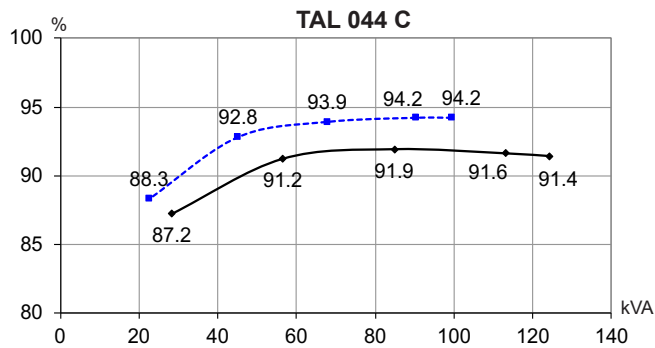
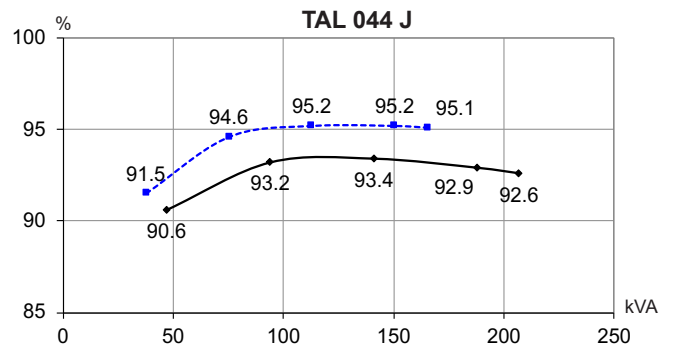
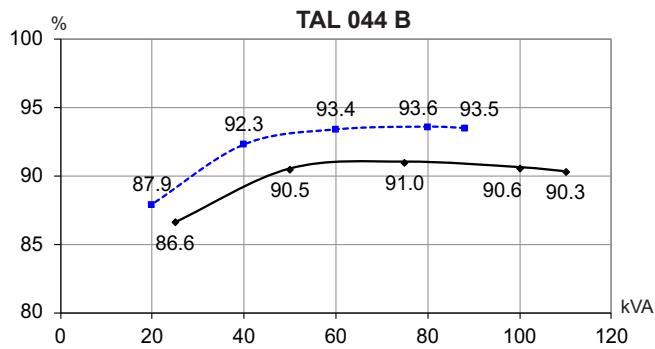
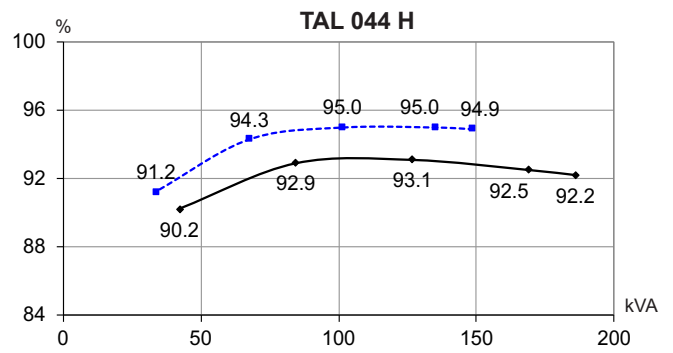
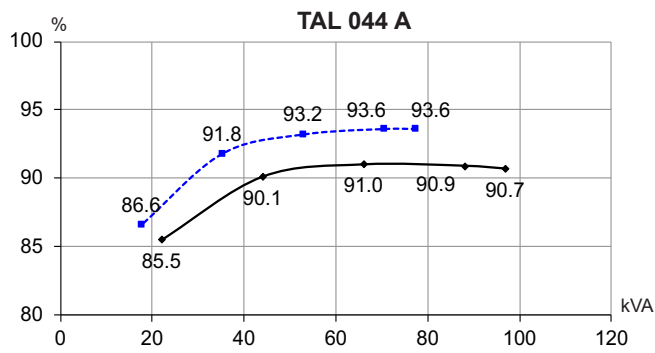

Reactances (%). Time constants (ms) - Class H / 400 V

	A	B	C	D	E	H	J	K	L	M
Kcc Short-circuit ratio	0.57	0.5	0.53	0.48	0.43	0.4	0.4	0.42	0.37	0.33
Xd Direct-axis synchronous reactance unsaturated	294	336	307	341	334	361	359	343	343	381
Xq Quadrature-axis synchronous reactance unsaturated	150	171	156	174	170	184	183	175	175	194
T'do No-load transient time constant	2475	2475	2308	2308	2154	2154	2112	2077	2025	2025
X'd Direct-axis transient reactance saturated	11.9	13.6	13.3	14.7	15.5	16.7	17	16.5	16.9	18.8
T'd Short-circuit transient time constant	100	100	100	100	100	100	100	100	100	100
X''d Direct-axis subtransient reactance saturated	7.1	8.1	7.9	8.8	9.3	10	10.2	9.9	10.1	11.3
T''d Subtransient time constant	10	10	10	10	10	10	10	10	10	10
X''q Quadrature-axis subtransient reactance saturated	16.1	18.3	17	18.9	18.9	20.4	20.4	19.5	19.7	21.9
Xo Zero sequence reactance	0.49	0.56	0.55	0.61	0.64	0.69	0.7	0.68	0.7	0.78
X2 Negative sequence reactance saturated	11.62	13.28	12.53	13.92	14.12	15.25	15.31	14.74	14.96	16.62
Ta Armature time constant	15	15	15	15	15	15	15	15	15	15

Other class H / 400 V data

io (A) No-load excitation current SHUNT	0.84	0.84	0.80	0.80	0.67	0.67	0.66	0.68	0.64	0.64
io (A) No-load excitation current AREP+	1.08	1.08	1.03	1.03	0.87	0.87	0.85	0.88	0.82	0.82
ic (A) On-load excitation current SHUNT	2.60	2.95	2.75	3.08	2.57	2.78	2.79	2.82	2.69	3.01
ic (A) On-load excitation current AREP+	3.35	3.80	3.54	3.96	3.31	3.59	3.60	3.63	3.46	3.88
uc (V) On-load excitation voltage SHUNT	28.9	32.5	30.1	33.2	31.9	34.3	34.1	34.1	20.1	22.2
uc (V) On-load excitation voltage AREP+	23.2	26.1	24.1	26.7	25.6	27.5	27.4	27.4	15.8	17.5
ms Response time ($\Delta U = 20\%$ transient)	500	500	500	500	500	500	500	500	500	500
kVA Start ($\Delta U = 20\%$ cont. or $\Delta U = 30\%$ trans.) SHUNT*	124	124	143	143	204	205	225	254	318	318
kVA Start ($\Delta U = 20\%$ cont. or $\Delta U = 30\%$ trans.) AREP+*	203	203	233	233	333	334	366	413	542	543
% Transient ΔU (on-load 4/4) SHUNT - P.F.: 0.8 _{LAG}	17.2	18.8	18.5	19.9	18.2	19.1	19.3	18.9	17.3	18.6
% Transient ΔU (on-load 4/4) AREP+ - P.F.: 0.8 _{LAG}	12.5	13.6	13.4	14.4	13.2	13.8	13.9	13.7	12.2	13
W No-load losses	1980	1980	2175	2175	2322	2322	2478	2785	2665	2665
W Heat dissipation	5903	7091	6931	8053	8255	9254	9769	10184	10134	11898

* P.F. = 0.6

Reactances (%). Time constants (ms) - Class H / 480 V

	A	B	C	D	E	H	J	K	L	M
Kcc Short-circuit ratio	0.55	0.48	0.5	0.46	0.41	0.38	0.38	0.41	0.36	0.32
Xd Direct-axis synchronous reactance unsaturated	308	350	321	355	348	377	375	356	358	397
Xq Quadrature-axis synchronous reactance unsaturated	157	178	164	181	177	192	191	182	182	202
T'do No-load transient time constant	2475	2475	2308	2308	2154	2154	2112	2077	2025	2025
X'd Direct-axis transient reactance saturated	12.4	14.1	13.9	15.4	16.1	17.5	17.7	17.1	17.6	19.6
T'd Short-circuit transient time constant	100	100	100	100	100	100	100	100	100	100
X''d Direct-axis subtransient reactance saturated	7.4	8.5	8.3	9.2	9.7	10.5	10.6	10.3	10.6	11.7
T''d Subtransient time constant	10	10	10	10	10	10	10	10	10	10
X''q Quadrature-axis subtransient reactance saturated	16.8	19.1	17.8	19.7	19.6	21.3	21.3	20.3	20.5	22.8
Xo Zero sequence reactance	0.51	0.59	0.58	0.64	0.67	0.72	0.74	0.71	0.73	0.81
X2 Negative sequence reactance saturated	12.17	13.83	13.1	14.49	14.69	15.91	15.99	15.34	15.59	17.32
Ta Armature time constant	15	15	15	15	15	15	15	15	15	15

Other class H / 480 V data

io (A) No-load excitation current SHUNT	0.84	0.84	0.79	0.79	0.67	0.67	0.66	0.68	0.63	0.63
io (A) No-load excitation current AREP+	1.08	1.08	1.02	1.02	0.87	0.87	0.85	0.87	0.82	0.82
ic (A) On-load excitation current SHUNT	2.60	2.91	2.72	3.01	2.58	2.79	2.79	2.79	2.69	3.00
ic (A) On-load excitation current AREP+	3.34	3.76	3.51	3.88	3.32	3.59	3.60	3.59	3.47	3.87
uc (V) On-load excitation voltage SHUNT	29.3	32.6	30.3	33.3	32.4	34.8	34.7	34.4	20.4	22.6
uc (V) On-load excitation voltage AREP+	23.5	26.2	24.4	26.7	26	28	27.8	27.6	16.1	17.8
ms Response time ($\Delta U = 20\%$ transient)	500	500	500	500	500	500	500	500	500	500
kVA Start ($\Delta U = 20\%$ cont. or $\Delta U = 30\%$ trans.) SHUNT*	149	150	172	172	246	246	270	304	381	381
kVA Start ($\Delta U = 20\%$ cont. or $\Delta U = 30\%$ trans.) AREP+*	244	244	279	281	401	402	438	498	648	650
% Transient ΔU (on-load 4/4) SHUNT - P.F.: 0.8 _{LAG}	17.7	19.3	19.1	20.4	18.6	19.7	19.9	19.4	17.8	19.1
% Transient ΔU (on-load 4/4) AREP+ - P.F.: 0.8 _{LAG}	12.9	14	13.8	14.7	13.5	14.2	14.3	14	12.5	13.4
W No-load losses	2905	2905	3189	3189	3417	3417	3639	4070	3923	3923
W Heat dissipation	7042	8265	8222	9378	9683	10805	11438	11913	12145	14130

* P.F. = 0.6

Transient voltage variation 400V - 50 Hz

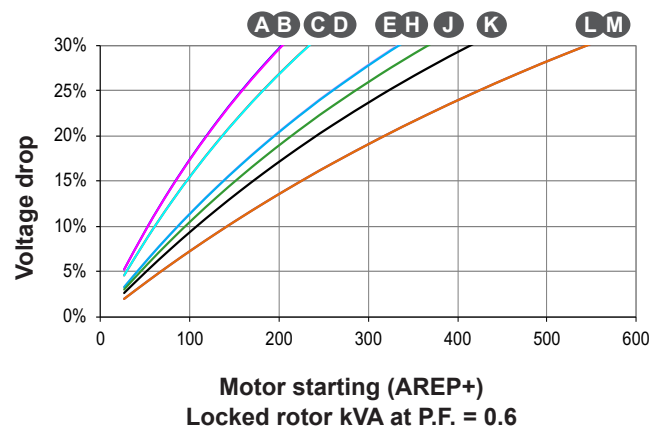
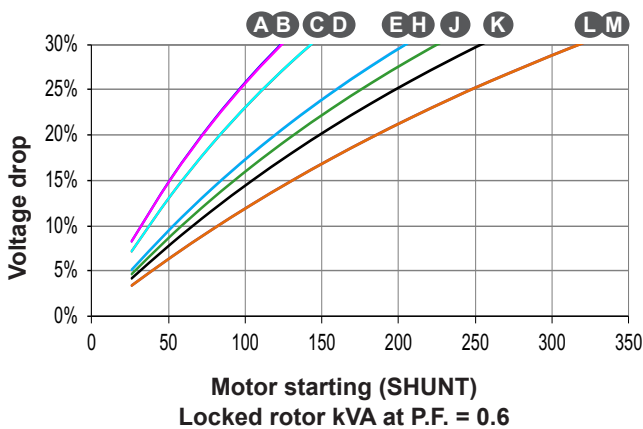
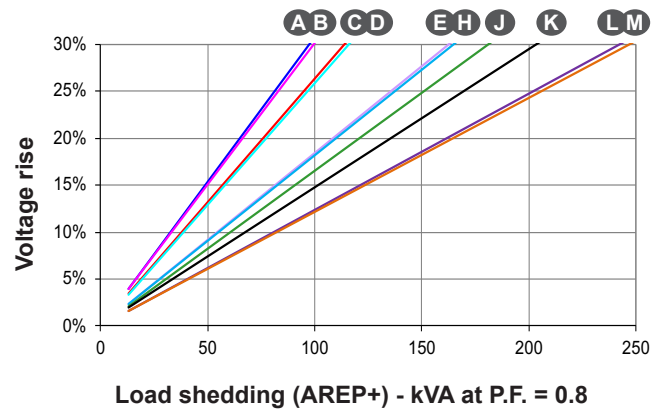
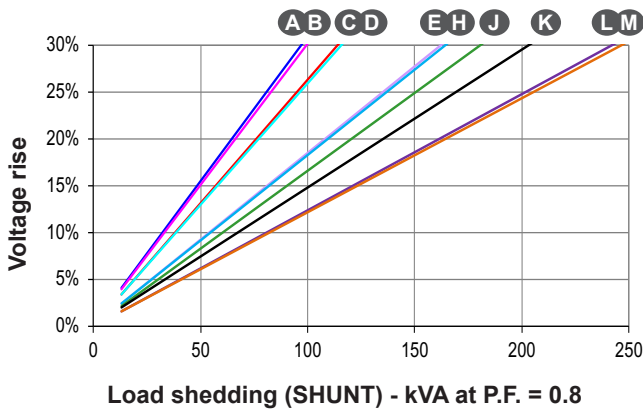
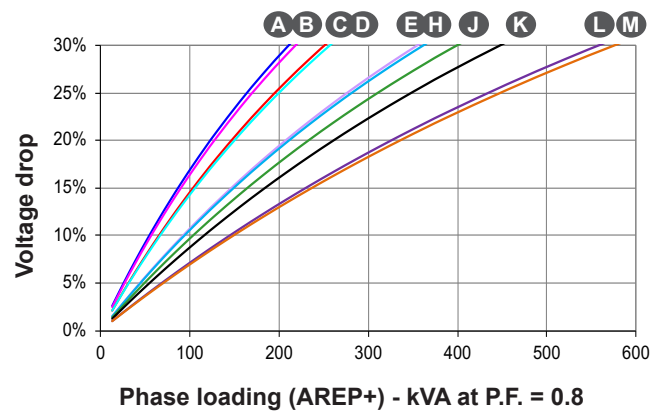
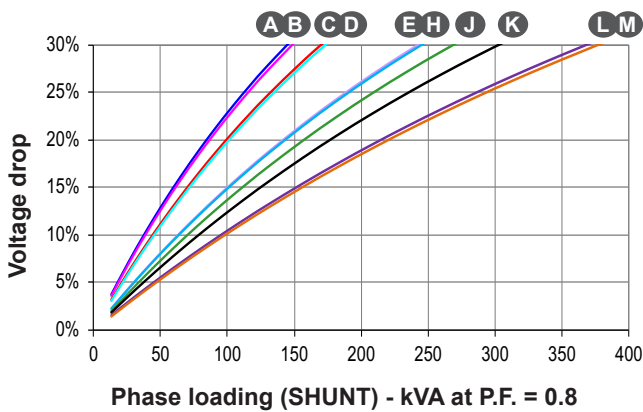

- For a starting P.F. other than 0.6, the starting kVA must be multiplied by $K = \text{Sine P.F.} / 0.8$
- For voltages other than 400V (Y), 230V (Δ) at 50 Hz, then kVA must be multiplied by $(400/U)^2$ or $(230/U)^2$.
- Transient performance of the PMG option, consult us.

Transient voltage variation 480V - 60 Hz

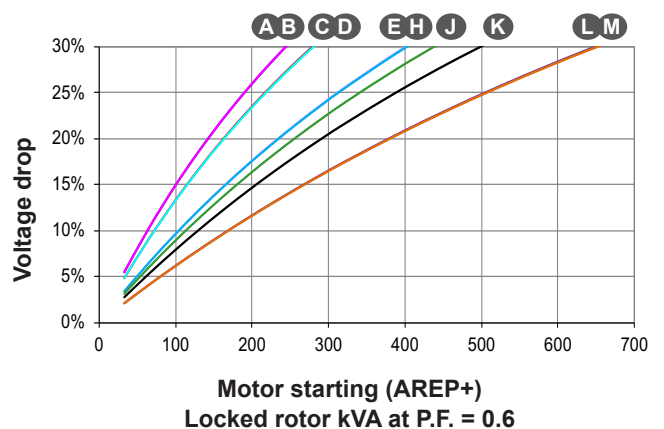
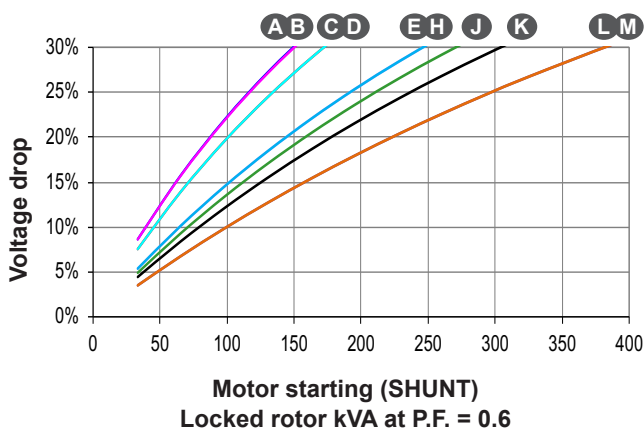
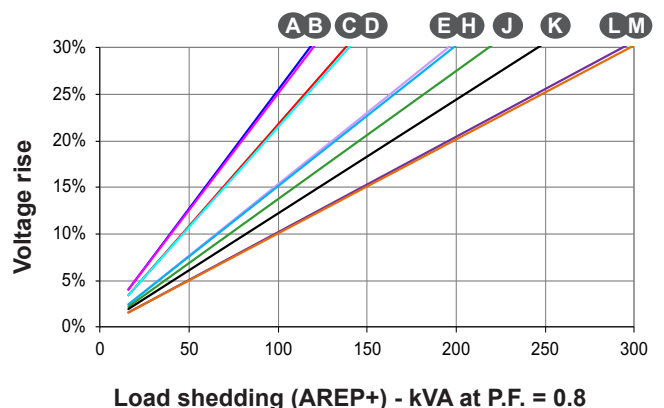
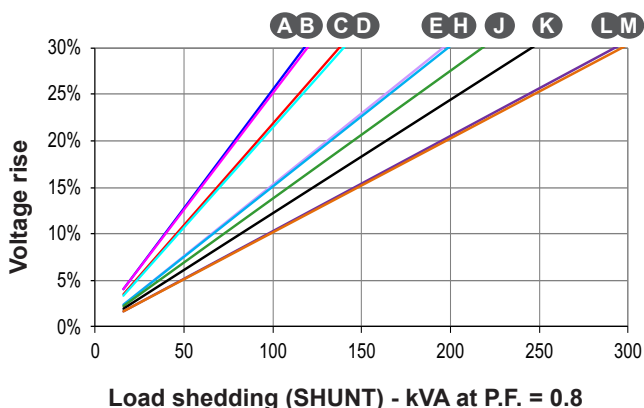
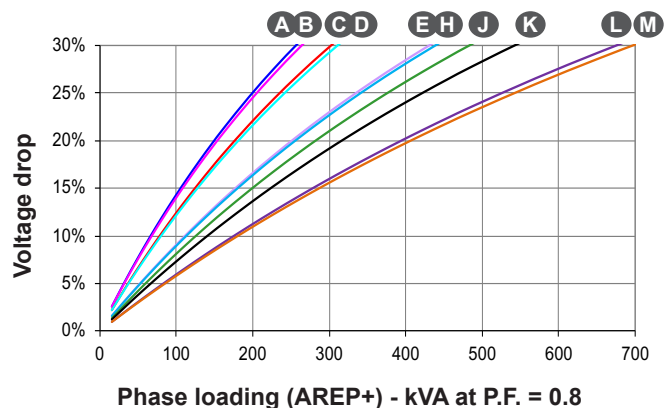
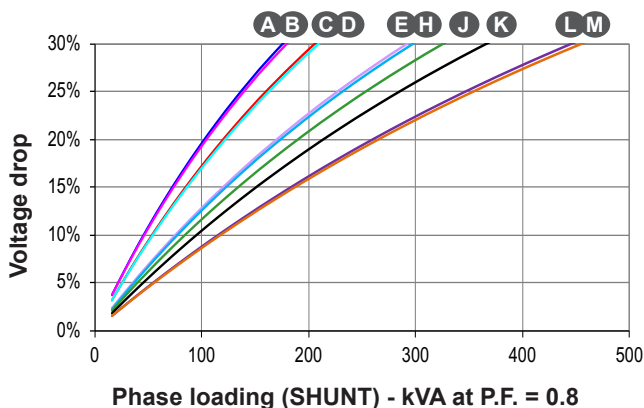

- For a starting P.F. other than 0.6, the starting kVA must be multiplied by $K = \text{Sine P.F.} / 0.8$
- For voltages other than 480V (Y), 277V (Δ), 240V (YY) at 60 Hz, then kVA must be multiplied by $(480/U)^2$ or $(277/U)^2$ or $(240/U)^2$.
- Transient performance of the PMG option, consult us.

3-phase short-circuit curves at no load and rated speed (star connection Y)

TAL 044 A

Symmetrical —
Asymmetrical - - -

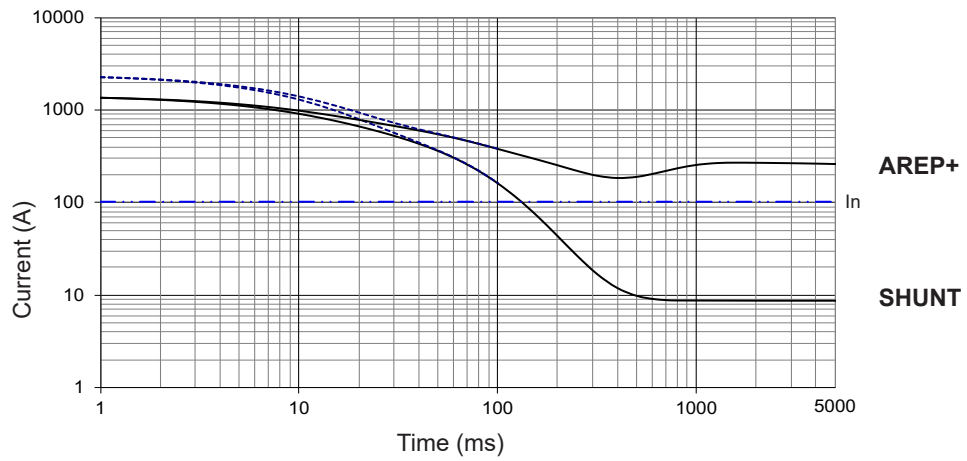

TAL 044 B

Symmetrical —
Asymmetrical - - -

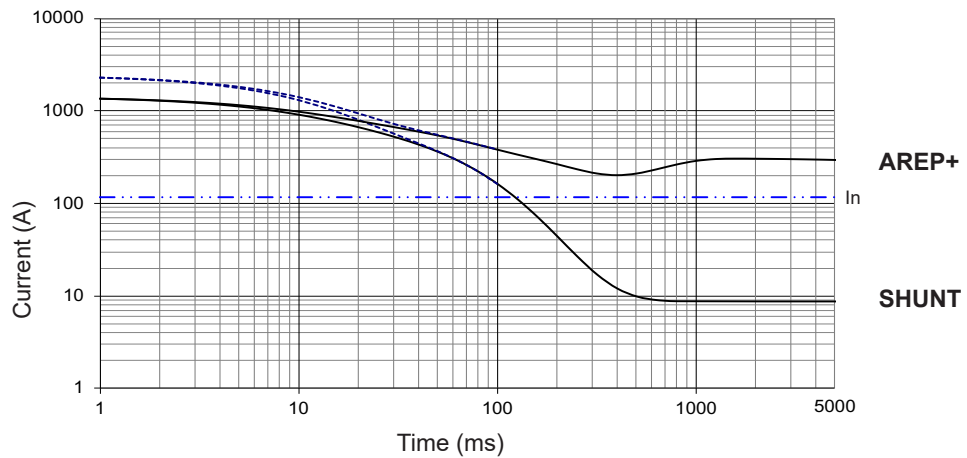

TAL 044 C

Symmetrical —
Asymmetrical - - -

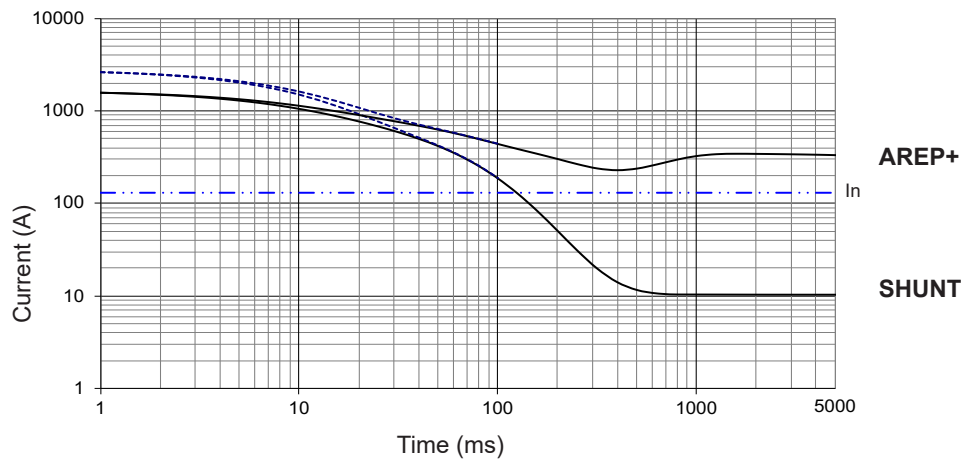

Influence due to connection

For (Δ) connection, use the following multiplication factor:
- Current value x 1.732.

3-phase short-circuit curves at no load and rated speed (star connection Y)

TAL 044 D

Symmetrical —
Asymmetrical - - -

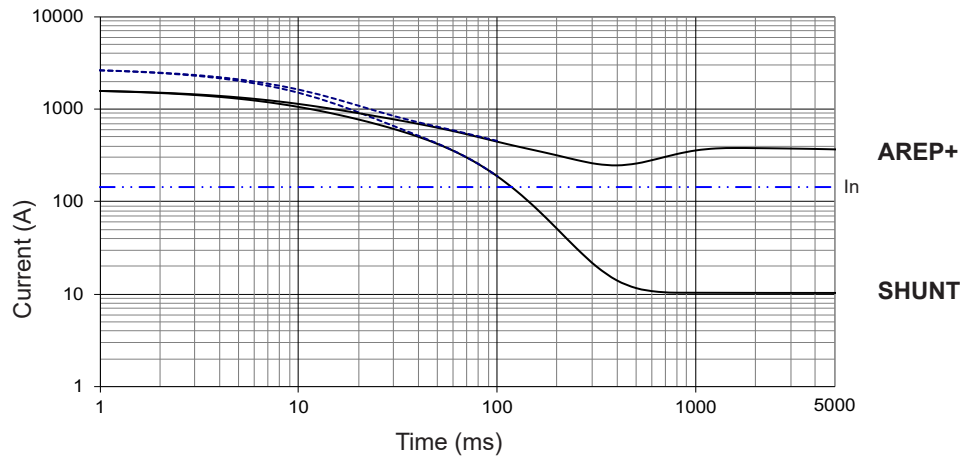

TAL 044 E

Symmetrical —
Asymmetrical - - -

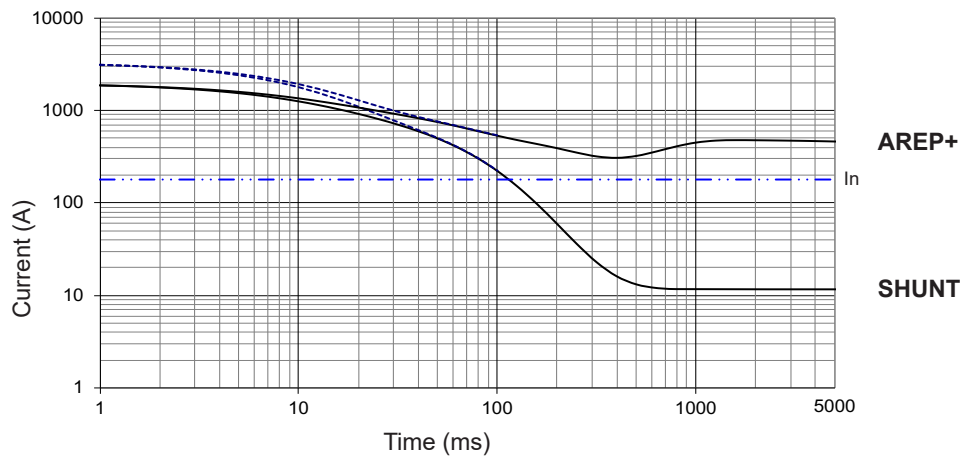

TAL 044 H

Symmetrical —
Asymmetrical - - -

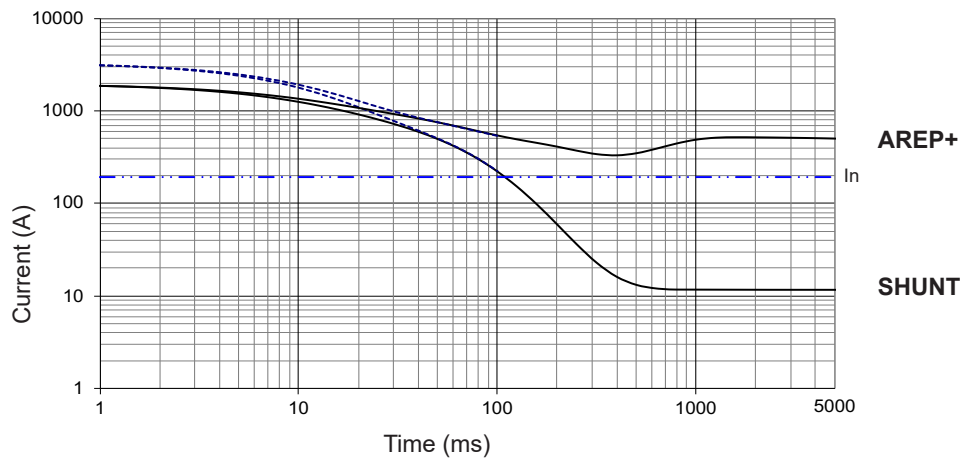

Influence due to short-circuit

Curves are based on a three-phase short-circuit.
For other types of short-circuit,
use the following multiplication factors.

	3 - phase	2 - phase L / L	1 - phase L / N
Instantaneous (max.)	1	0.87	1.3
Continuous	1	1.5	2.2
Maximum duration (AREP+/PMG)		1.5	

3-phase short-circuit curves at no load and rated speed (star connection Y)

TAL 044 J

Symmetrical —
Asymmetrical - - -

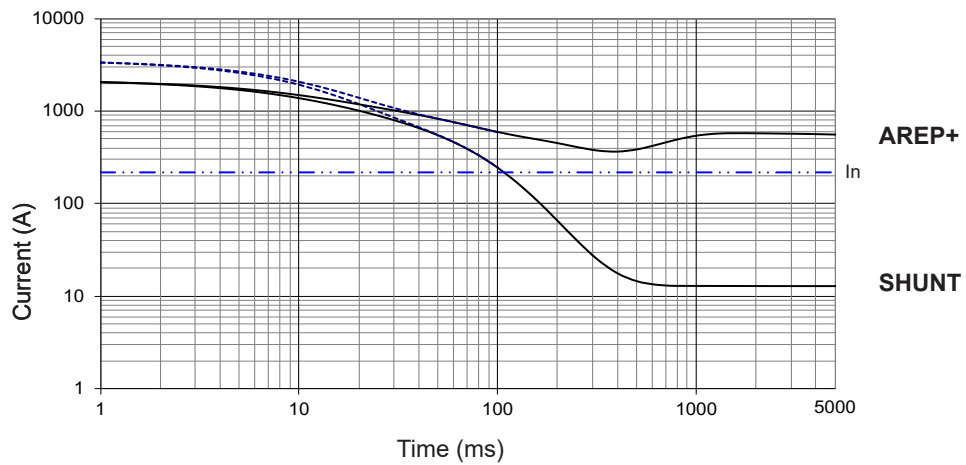

TAL 044 K

Symmetrical —
Asymmetrical - - -

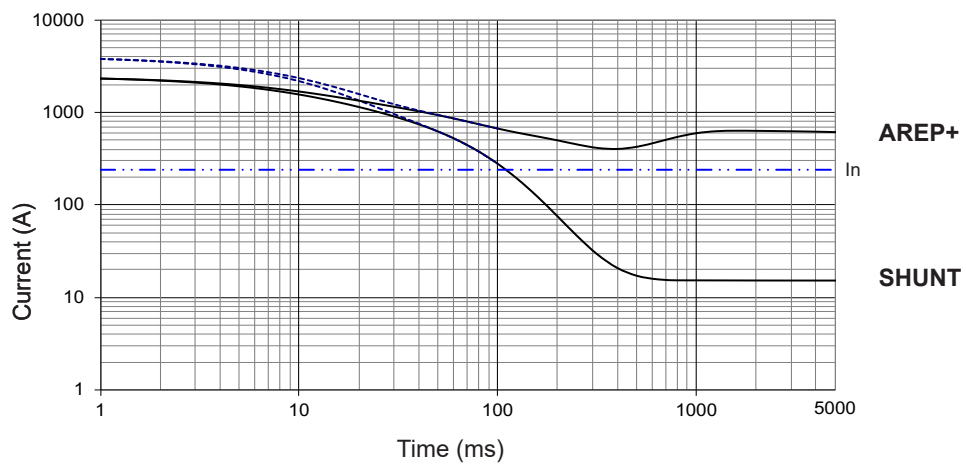

Influence due to connection

For (Δ) connection, use the following multiplication factor:
- Current value x 1.732.

3-phase short-circuit curves at no load and rated speed (star connection Y)

TAL 044 L

Symmetrical —
Asymmetrical - - -

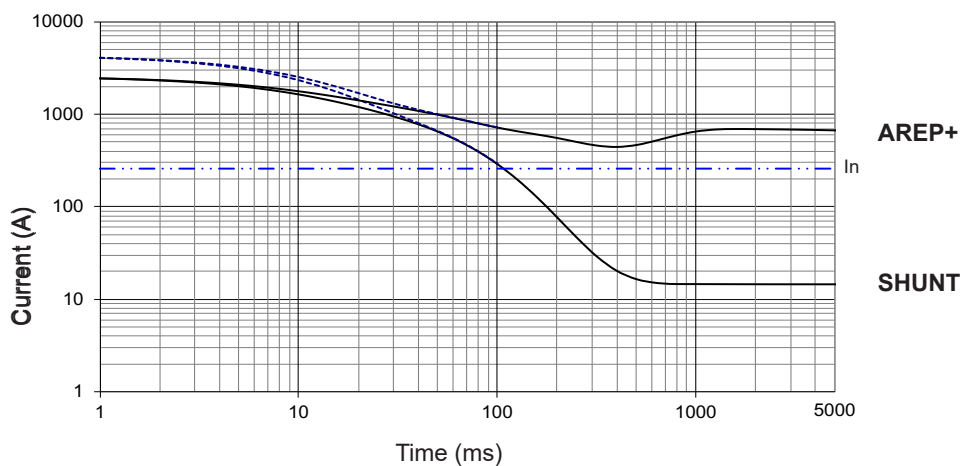

TAL 044 M

Symmetrical —
Asymmetrical - - -

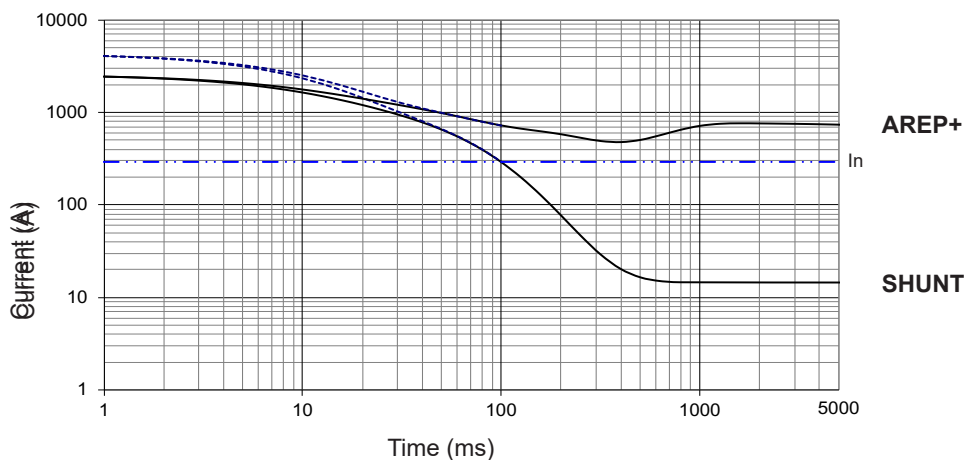

Influence due to short-circuit

Curves are based on a three-phase short-circuit.
For other types of short-circuit,
use the following multiplication factors.

	3 - phase	2 - phase L / L	1 - phase L / N
Instantaneous (max.)	1	0.87	1.3
Continuous	1	1.5	2.2
Maximum duration (AREP+/PMG)		1.5	

TAL 044 - Dedicated single-phase 57 to 82 kVA - 50 Hz / 80 to 125 kVA - 60 Hz

General characteristics

Insulation class	H	Excitation system	SHUNT
Winding pitch	2/3 (wind. M 50 Hz, M1 60 Hz)	AVR type	R121
Number of wires	4	Voltage regulation (*)	± 1 %
Protection	IP 23	Total Harmonic Distortion THD (**) in no-load	< 3.5 %
Altitude	≤ 1000 m	Total Harmonic Distortion THD (**) in linear load	< 5 %
Overspeed	2250 R.P.M.	Waveform: NEMA = TIF (**)	< 100
Air flow	0.25 m ³ /s (50 Hz) / 0.30 m ³ /s (60 Hz)	Waveform: I.E.C. = FHT (**)	< 2 %

(*) Steady state (**) Total harmonic distortion between phases, no-load or on-load (non-distorting)

Ratings / Efficiencies 50 Hz - 1500 R.P.M. - Winding M

kVA / kW - P.F. = 1(*)						
Duty / T° C	Continuous / 40 °C			Stand-by / 40 °C	Stand-by / 27 °C	
Class / T° K	H / 125° K	F / 105° K	H / 150° K	H / 163° K		
Serie (SE) 	230 V	η %	230 V	230 V	230V	η %
TAL 044 C	57	91	52	60	63	90.7
TAL 044 D1	69	91.5	63	73	76	91.1
TAL 044 E	-	-	-	-	-	-
TAL 044 J	82	92.3	75	87	90	92
TAL 044 K	-	-	-	-	-	-

(*) For P.F. 0.8: derating 15%

Ratings / Efficiencies 60 Hz - 1800 R.P.M. - Winding M1

kVA / kW - P.F. = 1(*)						
Duty / T° C	Continuous / 40 °C			Stand-by / 40 °C	Stand-by / 27 °C	
Class / T° K	H / 125° K	F / 105° K	H / 150° K	H / 163° K		
Serie (SE) 	240 V	η %	240 V	240 V	240V	η %
TAL 044 C	80	90	73	85	88	89.7
TAL 044 D1	100	90	91	106	110	89.7
TAL 044 E	115	90.7	105	122	127	90.2
TAL 044 J	-	-	-	-	-	-
TAL 044 K	125	91.7	114	133	138	91.4

(*) For P.F. 0.8: derating 15%

Starting motor 230V - 50Hz

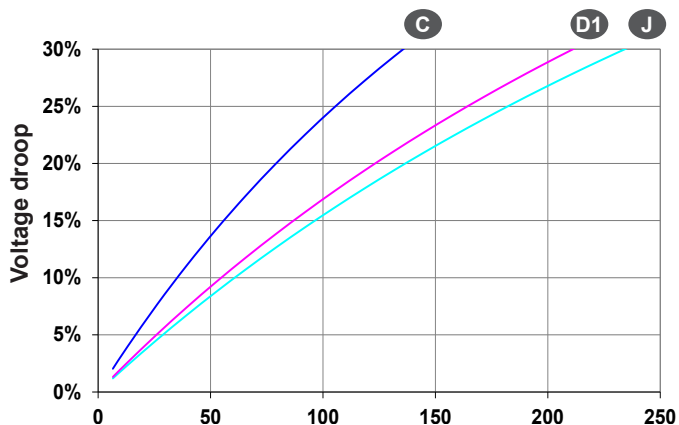

Starting motor 240V - 60Hz

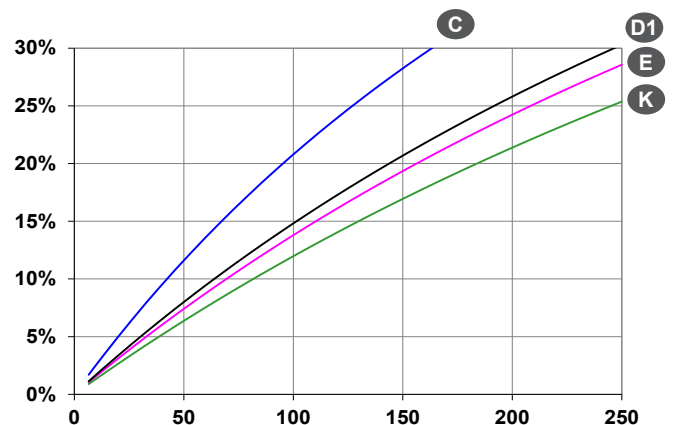

Locked rotor kVA at PF : 0.9

Single-bearing dimensions

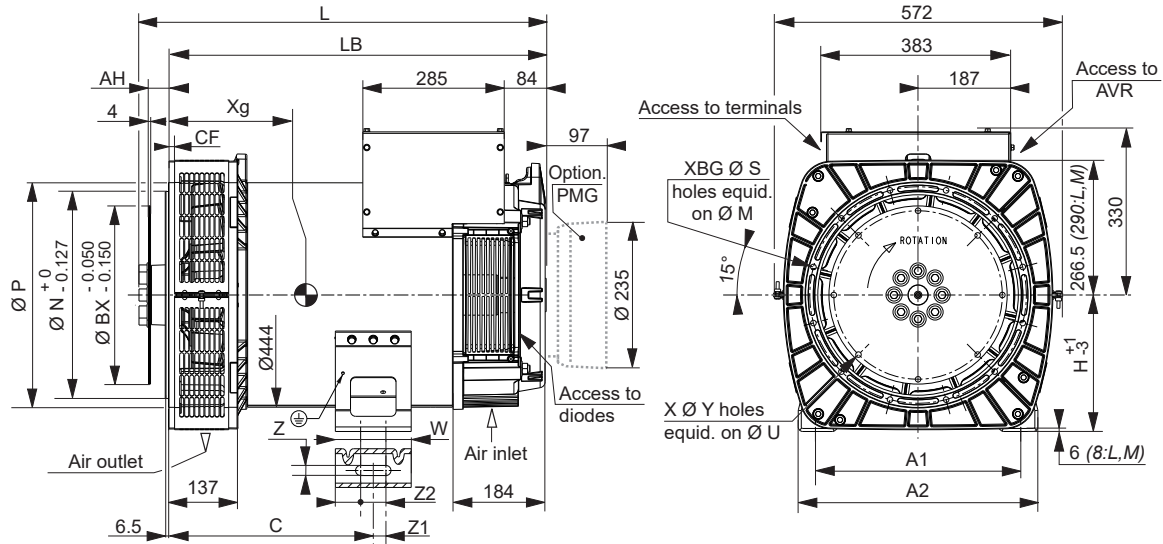

Dimensions (mm) and weight				
Type	L maxi *	LB	Xg	Weight (kg)
TAL 044 A	758	677	293	247
TAL 044 B	758	677	293	247
TAL 044 C	758	677	313	280
TAL 044 D	758	677	313	280
TAL 044 D1	758	677	313	280
TAL 044 E	828	747	353	353
TAL 044 H	828	747	353	353
TAL 044 J	828	747	365	383
TAL 044 K	868	787	383	418
TAL 044 L	953	872	416	539
TAL 044 M	953	872	416	539

* L maxi = LB + AH maxi + 19

Flange (mm)						
S.A.E.	P	N	M	S	XBG	CF
4	400	361.95	381	11	12	16
3	445	409.58	428.62	11	12	16
2	485	447.68	466.72	11	12	16
1	560.5/581*	511.18	530.23	12	10	4.5/10*

* Specific dimension TAL 044 L and M

Shaft height (mm)				Coupling				
H	Standard		Option	Flex plate	1	2	3	4
	270	225*	280**					
C	405	332.5	429	14	x	-	-	-
A1	406	356	457	11 1/2	x	x	x	-
A2	474	430	541	8	-	-	x	x
Z	20	14.5	20					
Z1	25	20	25					
Z2	50	40	50					
W	150	120	150					

* Not available for L and M

** Available only for L and M

Flex plate (mm)					
S.A.E.	BX	U	X	Y	AH
14	466.72	438.15	8	14	25.4
11 1/2	352.42	333.38	8	11	39.6
10	314.32	295.28	8	11	53.8
8	263.52	244.48	6	11	62

Torsional analysis data

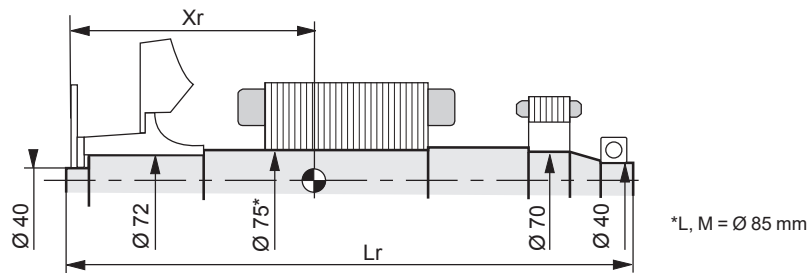

Centre of gravity: Xr (mm), Rotor length: Lr (mm), Weight: M (kg), Moment of inertia: J (kgm²): (4J = MD²)																
Flex plate	S.A.E. 8				S.A.E. 10				S.A.E. 11 1/2				S.A.E. 14			
	Type	Xr	Lr	M	J	Xr	Lr	M	J	Xr	Lr	M	J	Xr	Lr	M
TAL 044 A	352.4	727	107.1	0.739	362.4	719	107.2	0.753	349.3	704	106.8	0.769	298.6	711	113.8	0.899
TAL 044 B	352.4	727	107.1	0.739	362.4	719	107.2	0.753	349.3	704	106.8	0.769	298.6	711	113.8	0.899
TAL 044 C	362.5	727	120.9	0.863	353.2	719	121.0	0.877	340.3	704	120.6	0.893	310.0	711	127.6	1.023
TAL 044 D	362.5	727	120.9	0.863	353.2	719	121.0	0.877	340.3	704	120.6	0.893	310.0	711	127.6	1.023
TAL 044 D1	362.5	727	120.9	0.863	353.2	719	121.0	0.877	340.3	704	120.6	0.893	310.0	711	127.6	1.023
TAL 044 E	408.5	797	153.6	1.137	398.5	789	153.7	1.151	385.4	774	153.3	1.167	357.3	781	160.2	1.297
TAL 044 H	408.5	797	153.6	1.137	398.5	789	153.7	1.151	385.4	774	153.3	1.167	357.3	781	160.2	1.297
TAL 044 J	419.4	797	165.4	1.244	409.3	789	165.5	1.258	396.2	774	165.1	1.274	368.8	781	172.0	1.404
TAL 044 K	439.4	837	180.7	1.379	429.2	829	180.8	1.393	416.0	814	180.4	1.409	389.2	821	187.4	1.539
TAL 044 L	480.9	922	221.1	1.713	471.3	914	221.2	1.727	458.3	899	220.8	1.743	449.6	906	227.8	1.873
TAL 044 M	480.9	922	221.1	1.713	471.3	914	221.2	1.727	458.3	899	220.8	1.743	449.6	906	227.8	1.873

NOTE : Dimensions are for information only and may be subject to modifications. The torsional analysis of the transmission is imperative. All values are available upon request.



www.nidecpower.com

Connect with us at:



© 2024 Moteurs Leroy-Somer SAS. The information contained in this brochure is for guidance only and does not form part of any contract. The accuracy cannot be guaranteed as Moteurs Leroy-Somer SAS have an ongoing process of development and reserve the right to change the specification of their products without notice.

Moteurs Leroy-Somer SAS. Headquarters: Bd Marcellin Leroy, CS 10015, 16915 Angoulême Cedex 9, France. Share Capital: 32,239,235 €, RCS Angoulême 338 567 258.